



Standard Test Method for Thermal Oxidation Stability of Aviation Turbine Fuels (JFTOT Procedure)¹

This standard is issued under the fixed designation D 3241; the number immediately following the designation indicates the year of original adoption or, in the case of revision, the year of last revision. A number in parentheses indicates the year of last reapproval. A superscript epsilon (ϵ) indicates an editorial change since the last revision or reapproval.

This standard has been approved for use by agencies of the Department of Defense.

^{ε1} NOTE—Corrected Footnote 7 editorially in December 2003.

1. Scope

1.1 This test method covers the procedure for rating the tendencies of gas turbine fuels to deposit decomposition products within the fuel system.

1.2 The values stated in SI units are to be regarded as the standard. The inch-pound values given in parentheses are for information only. The differential pressure values in mm Hg are defined only in terms of this test method.

1.3 *This standard does not purport to address all of the safety concerns, if any, associated with its use. It is the responsibility of the user of this standard to establish appropriate safety and health practices and determine the applicability of regulatory limitations prior to use.* For specific hazard statements, see 6.1.1, 7.2, 7.2.1, 7.3, 11.1.1, and Annex A3.

2. Referenced Documents

2.1 ASTM Standards:

D 1655 Specification for Aviation Turbine Fuels²

D 4306 Practice for Aviation Fuel Sample Containers for Tests Affected by Trace Contamination³

E 177 Practice for Use of the Terms Precision and Bias in ASTM Test Methods⁴

E 691 Practice for Conducting an Interlaboratory Study to Determine the Precision of a Test Method⁴

2.2 ASTM Adjuncts:

Color Standard for Tube Deposit Rating⁵

¹ This test method is under the jurisdiction of ASTM Committee D02 on Petroleum Products and Lubricants and is the direct responsibility of Subcommittee D02.J0 on Aviation Fuels.

Current edition approved Nov. 10, 2002. Published January 2003. Originally approved in 1973. Last previous edition approved in 2002 as D 3241–02.

² *Annual Book of ASTM Standards*, Vol 05.01.

³ *Annual Book of ASTM Standards*, Vol 05.02.

⁴ *Annual Book of ASTM Standards*, Vol 14.02.

⁵ Available from ASTM Headquarters. Order Adjunct No. ADJD3241.

3. Terminology

3.1 Definitions of Terms Specific to This Standard:

3.1.1 *deposits*—oxidative products laid down on the test area of the heater tube or caught in the test filter, or both.

3.1.1.1 *Discussion*—Fuel deposits will tend to predominate at the hottest portion of the heater tube which is between the 30 mm and 50 mm position.

3.1.2 *heater tube*—an aluminum coupon controlled at elevated temperature, over which the test fuel is pumped.

3.1.2.1 *Discussion*—The tube is resistively heated and controlled in temperature by a thermocouple positioned inside. The critical test area is the thinner portion, 60 mm in length, between the shoulders of the tube. Fuel inlet to the tube is at the 0 mm position, and fuel exit is at 60 mm.

3.2 Abbreviations:

3.2.1 ΔP —differential pressure.

4. Summary of Test Method

4.1 This test method for measuring the high temperature stability of gas turbine fuels uses the Jet Fuel Thermal Oxidation Tester (JFTOT) that subjects the test fuel to conditions that can be related to those occurring in gas turbine engine fuel systems. The fuel is pumped at a fixed volumetric flow rate through a heater after which it enters a precision stainless steel filter where fuel degradation products may become trapped.

4.1.1 The apparatus uses 450 mL of test fuel ideally during a 2.5 h test. The essential data derived are the amount of deposits on an aluminum heater tube, and the rate of plugging of a 17 μ nominal porosity precision filter located just downstream of the heater tube.

5. Significance and Use

5.1 The test results are indicative of fuel performance during gas turbine operation and can be used to assess the level

TABLE 1 Models of JFTOT

JFTOT Model	User Manual	Pressurize With	Pump Principle	Differential Pressure By
202	202/203 ^A	nitrogen	gear	Hg Manometer; No Record
203	202/203 ^A	nitrogen	gear	Manometer + Graphical Record
215	215 ^B	nitrogen	gear	Transducer + Printed Record
230	230/240 ^C	hydraulic	syringe	Transducer + Printout
240	230/240 ^C	hydraulic	syringe	Transducer + Printout

^A Available from ASTM Headquarters. Request RR:D02-1395.

^B Available from ASTM Headquarters. Request RR:D02-1396.

^C Available from ASTM Headquarters. Request RR:D02-1397.

of deposits that form when liquid fuel contacts a heated surface that is at a specified temperature.

6. Apparatus

6.1 *Jet Fuel Thermal Oxidation Tester*⁶ (JFTOT)—Five models of suitable equipment may be used as indicated in Table 1.

6.1.1 Portions of this test may be automated. Refer to the appropriate user manual for the model JFTOT to be used for a description of detailed procedure. A manual is provided with each test rig, and the latest version of each manual is on file at ASTM as a Research Report.⁷ (**Warning**—No attempt should be made to operate the JFTOT without first becoming acquainted with all components and the function of each.)

6.1.2 Certain operational parameters used with the JFTOT instrument are critically important to achieve consistent and correct results. These are listed in Table 2.

6.2 *Heater Tube Deposit Rating Apparatus*:

6.2.1 *Visual Tube Rater*, the tuberator described in Annex A1.

7. Reagents and Materials

7.1 Use distilled (preferred) or deionized water in the spent sample reservoir as required for Model 230 and 240 JFTOTs.

7.2 Use methyl pentane, 2,2,4 trimethylpentane or n-heptane (technical grade, 95 mol % minimum purity) as general cleaning solvent. This solvent will effectively clean internal metal surfaces of apparatus before a test, especially those surfaces (before the test section) that contact fresh sample. (**Warning**—Extremely flammable. Harmful if inhaled (see Annex A3)).

7.2.1 Use trisolvant (equal mix of acetone (1), toluene (2), and isopropanol (3)) as a specific solvent to clean internal (working) surface of test section only. (**Warning**—(1) Extremely flammable, vapors may cause flash fire; (2) and (3) Flammable. Vapors of all three harmful. Irritating to skin, eyes and mucous membranes.)

⁶ The following equipment (JFTOT) as described in Table 1 and RR:D02-1395, RR: D02-1396, and RR: D02-1397, was used to develop this test method, as provided by Alcor Petroleum Instruments, 919 Isom, San Antonio, TX 78216. This is not an endorsement or certification by ASTM International.

⁷ The following equipment, heater tubes, manufactured by Alcor Petroleum Instruments, 919 Isom, San Antonio, TX 78216, was used in the development of this test method. This is not an endorsement or certification by ASTM International.

7.3 Use dry calcium sulfate + cobalt chloride granules (97 + 3 mix) in the aeration dryer. This granular material changes gradually from blue to pink color indicating absorption of water. (**Warning**—Do not inhale dust or ingest. May cause stomach disorder.)

8. Standard Operating Conditions

8.1 Standard conditions of the test method are as follows:

8.1.1 *Fuel Quantity*, 450-mL minimum for test + about 50 mL for system.

8.1.2 *Fuel Pre-treatment*—Filtration through a single layer of general purpose, retentive, qualitative filter paper followed by a 6-min aeration at 1.5 L/min air flow rate for a maximum of 600 mL sample using a coarse 12-mm borosilicate glass gas dispersion tube.

8.1.3 *Fuel System Pressure*, 3.45 MPa (500 psi) ± 10 % gage.

8.1.4 *Thermocouple Position*, at 39 mm.

8.1.5 *Fuel System Prefilter Element*, filter paper of 0.45 µm pore size.

8.1.6 *Heater Tube Control Temperature*, preset as specified in applicable specification.

8.1.7 *Fuel Flow Rate*, 2.7 to 3.3 mL/min, or 20 drops of fuel in 9.0 ± 1.0 s.

8.1.8 *Minimum Fuel Pumped During Test*, 405 mL.

8.1.9 *Test Duration*, 150 ± 2 min.

8.1.10 *Cooling Fluid Flow*, approximately 39 L/h, or center of green range on cooling fluid meter.

8.1.11 *Power Setting*, approximately 75 to 100 on non-computer models; internally set for computer models.

9. Preparation of Apparatus

9.1 *Cleaning and Assembly of Heater Test Section*:

9.1.1 Clean the inside surface of the heater test section using a nylon brush saturated with trisolvant material to remove all deposits.

9.1.2 Check the heater tube to be used in the test for surface defects and straightness by referring to the procedure in Annex A1.10. Be careful, also, to avoid scratching tube shoulder during the examination since the tube shoulder must be smooth to ensure a seal under the flow conditions of the test.

9.1.3 Assemble the heater section using new items: (1) visually checked heater tube, (2) test filter, and (3) three O-rings. Inspect insulators to be sure they are undamaged.

NOTE 1—Heater tubes must not be reused. Tests indicate that magnesium migrates to the heater tube surface under normal test conditions. Surface magnesium may reduce adhesion of deposits to reused heater tube.

9.1.4 During assembly of heater section, handle tube carefully so as not to touch center part of tube. IF CENTER OF HEATER TUBE IS TOUCHED, REJECT THE TUBE SINCE THE CONTAMINATED SURFACE MAY AFFECT THE DEPOSIT FORMING CHARACTERISTICS OF THE TUBE.

9.2 *Cleaning and Assembly of Remainder of Test Components*:

9.2.1 Perform the following steps in the order shown prior to running a subsequent test.

NOTE 2—It is assumed apparatus has been disassembled from previous

TABLE 2 Critical Operating Characteristics of JFTOT Instruments

Item	Definition		
Test apparatus	tube-in-shell heat exchanger as illustrated in Fig. 1.		
Test coupons			
Heater tube ⁶	<p>specialty fabricated aluminum tube that produces controlled heated test surface; new one for each test</p> <p>Each JFTOT tube may be physically identified with a unique serial number, identifying the manufacturer and providing traceability to the original material batch</p> <p>6061-T6 Aluminum, plus the following criteria</p> <p>a) The Mg:Si ratio shall not exceed 1.9:1</p> <p>b) The Mg₂Si percentage shall not exceed 1.85 %</p>		
Tube Identification			
Tube Metallurgy			
Tube Dimensions	Dimension		Tolerance
Tube Length, mm	161.925		±0.254
Center Section length, mm	60.325		±0.051
Outside Diameters, mm			
Shoulders	4.699		±0.025
Center Section	3.175		±0.051
Inside Diameter, mm	1.651		±0.051
Total Indicator Runout, mm, Max	0.013		
Mechanical Surface Finish, nm, Max	50		
Test filter ⁶	nominal 17 µm stainless steel mesh filter element to trap deposits; new one for each test		
Instrument parameters			
Sample volume	600 mL of sample is aerated, then this aerated fuel is used to fill the reservoir leaving space for the piston; 450 ± 45 mL may be pumped in a valid test		
Aeration rate	1.5 L/min dry air through sparger		
Flow during test	3.0 ± 10 % mL/min (2.7 min to 3.3 max)		
Pump mechanism	positive displacement, gear or piston syringe		
Cooling	bus bars fluid cooled to maintain consistent tube temperature profile		
Thermocouple (TC)	Type J, fibre braid or Iconel sheathed		
Operating pressure System	3.45 MPa ± 10 % on sample by pressurized inert gas (nitrogen) or by hydraulically transmitted force against control valve outlet restriction		
At test filter	differential pressure (ΔP) measured across test filter (by mercury manometer or by electronic transducer) in mm Hg		
Operating temperature			
For test	as stated in specification for fuel		
Uniformity of run	maximum deviation of ±2°C from specified temperature		
Calibration	pure tin at 232°C (and for Models 230 and 240 only, pure lead at 327°C for high point and ice + water for low point reference)		

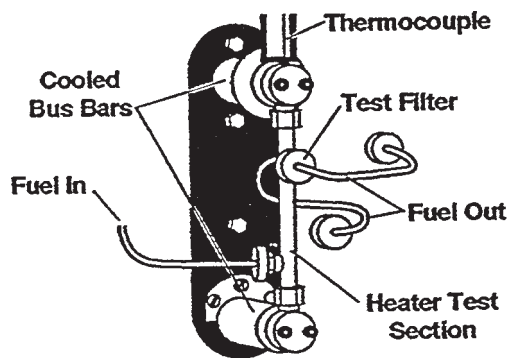

FIG. 1 Standard Heater Section, Essential to All JFTOT Instruments

test (see Annex A2 or appropriate user manual for assembly/disassembly details).

9.2.2 Inspect and clean components that contact test sample and replace any seals that are faulty or suspect especially the: (1) lip seal on piston, and (2) O-rings on the reservoir cover, lines, and prefilter cover.

9.2.3 Install prepared heater section (as described in 9.1.1 through 9.1.4).

9.2.4 Assemble pre-filter with new element and install.

9.2.5 Check thermocouple for correct reference position, then lower into standard operating position.

9.2.6 On Models 230 and 240 make sure the water beaker is empty.

10. Calibration and Standardization Procedure

10.1 Perform checks of key components at the frequency indicated in the following (see Annexes or user manual for details).

10.1.1 *Thermocouple*—Calibrate a thermocouple when first installed and then normally every 30 to 50 tests thereafter, but at least every 6 months (see A2.2.8).

10.1.2 *Differential Pressure Cell*—Standardize once a year or when installing a new cell (see A2.2.6).

10.1.3 *Aeration Dryer*—Check at least monthly and change if color indicates significant absorption of water (see 7.3).

10.1.4 *Metering Pump*—Perform two checks of flow rate for each test as described in the Procedure section.

10.1.5 *Filter Bypass Valve*—For Models 202, 203, and 215—check for leakage at least once a year (see X1.5).

11. Procedure

11.1 *Preparation of Fuel Test Sample:*

11.1.1 Filter and aerate sample using standard operating conditions (see A2.2.9). (**Warning**—All jet fuels must be considered flammable except JP5 and JP7. Vapors are harmful (see A3.3, A3.6, and A3.7)).

NOTE 3—Before operating see **Warning** in 6.1.1.

NOTE 4—Test method results are known to be sensitive to trace contamination from sampling containers. For recommended containers, refer to Practice D 4306.

11.1.2 Maintain temperature of sample between 15°C and 32°C during aeration. Put reservoir containing sample into hot or cold water bath to change temperature, if necessary.

11.1.3 Allow no more than 1 h to elapse between the end of aeration and the start of the heating of the sample.

11.2 *Final Assembly:*

11.2.1 Assemble the reservoir section (see User Manual).

11.2.2 Install reservoir and connect lines appropriate to the model JFTOT being used (see User Manual).

11.2.3 Remove protective cap and connect fuel outlet line to heater section. Do this quickly to minimize loss of fuel.

11.2.4 Check all lines to ensure tightness.

11.2.5 Recheck thermocouple position at 39 mm.

11.2.6 Make sure drip receiver is empty (Models 230 and 240 only).

11.3 *Power Up and Pressurization:*

11.3.1 Turn POWER to ON.

11.3.2 Energize the ΔP alarms on models with manual alarm switch (Models 202, 203, and 215).

11.3.3 Pressurize the system slowly to about 3.45 MPa as directed in the User Manuals for Models 202, 203, and 215 (see also A2.2.5).

11.3.4 Inspect the system for leaks. Depressurize the system as necessary to tighten any leaking fittings.

11.3.5 Set controls to the standard operating conditions.

11.3.6 Use a heater tube control temperature as specified for the fuel being tested. Apply any thermocouple correction from the most recent calibration (see A2.2.8).

NOTE 5—The JFTOT can be run to a maximum tube temperature of about 350°C. The temperature at which the test should be run, and the criteria for judging results are normally embodied in fuel specifications.

11.4 *Start Up:*

11.4.1 Use procedure for each model as described in the appropriate User Manual.

11.4.2 Some JFTOT models may do the following steps automatically, but verify that:

11.4.2.1 No more than 1 h maximum elapses from aeration to start of heating.

11.4.2.2 The manometer bypass valve is closed as soon as the heater tube temperature reaches the test level, so fuel flows through the test filter (see A2.2.6).

11.4.2.3 Manometer is set to zero (see A2.2.6).

11.4.3 Check fuel flow rate against Standard Operating Conditions by timing flow or counting the drip rate during first 15 min of test.

NOTE 6—When counting drop rate, the first drop is counted as drop 0, and time is started. As drop 20 falls, total time is noted.

11.5 *Test:*

11.5.1 Record filter pressure drop every 30 min minimum during the test period.

11.5.2 If the filter pressure drop begins to rise sharply and it is desired to run a full 150 min test, a bypass valve common to all models must be opened in order to finish the test. See appropriate User Manual for details on operation of the bypass system (see A2.2.2).

11.5.3 Make another flow check within final 15 min before shutdown (see 11.4.3 and accompanying note).

11.6 *Heater Tube Profile*—If a heater tube temperature profile is desired, obtain as described in X1.4.

11.7 *Shutdown:*

11.7.1 For Models 202, 203, and 215 only:

11.7.1.1 Switch HEATER, then PUMP to OFF.

11.7.1.2 Close NITROGEN PRESSURE VALVE and open MANUAL BYPASS VALVE.

11.7.1.3 Open NITROGEN BLEED VALVE slowly, if used, to allow system pressure to decrease at an approximate rate of 0.15 MPa/s.

11.7.2 Models 230 and 240 shut down automatically.

11.7.2.1 After shutdown, turn FLOW SELECTOR VALVE to VENT to relieve pressure.

11.7.2.2 Piston actuator will retreat automatically.

11.7.2.3 Measure effluent in drip receiver, then empty.

11.8 *Disassembly:*

11.8.1 Disconnect fuel inlet line to the heater section and cap to prevent fuel leakage from reservoir.

11.8.2 Disconnect heater section.

11.8.2.1 Remove heater tube from heater section carefully so as to avoid touching center part of tube, and discard test filter.

11.8.2.2 Flush tube with recommended general cleaning solvent (see 7.2) from top down. If the tube is grasped from the top, do not wash solvent over gloves or bare fingers. Allow to dry, return tube to original container, mark with identification and hold for evaluation.

11.8.3 Disconnect reservoir.

11.8.3.1 Measure the amount of spent fluid pumped during the test, and reject the test if the amount is less than 405 mL.

11.8.3.2 Discard fuel to waste disposal.

12. Heater Tube Evaluation

12.1 Visually rate the deposits on heater tube in accordance with Annex A1.

12.2 Return tube to original container, record data, and retain tube for visual record as appropriate.

13. Report

13.1 Report the following:

13.1.1 The heater tube control temperature. This is the test temperature of the fuel.

13.1.2 Heater tube deposit rating(s).

13.1.3 Maximum pressure drop across the filter during the test or the time required to reach a pressure differential of 25 mm Hg. For the Model 202, 203 JFTOT, report the maximum recorded ΔP found during the test.

13.1.4 If the normal 150 min test time was not completed, for example, if the test is terminated because of pressure drop failure, also report the test time that corresponds to this heater tube deposit rating.

NOTE 7—Either the tube rating or the ΔP criteria, or both, are used to determine whether a fuel sample passes or fails the test at a specified test temperature.

13.1.5 Spent fuel at the end of a normal test. This will be the amount on top of floating piston or total fluid in displaced water beaker, depending on model of JFTOT used.

13.1.6 Heater tube serial number may be reported.

14. Precision and Bias

14.1 An interlaboratory study of JFTOT testing was conducted in accordance with Practice E 691 by eleven laboratories, using thirteen instruments including two JFTOT models

with five fuels at two temperatures for a total of ten materials. Each laboratory obtained two results from each material. See ASTM Research Report No. D02:1309.

14.1.1 The terms repeatability and reproducibility in this section are used as specified in Practice E 177.

14.2 *Precision*—It is not possible to specify the precision of this test method because it has been determined that test method results cannot be analyzed by standard statistical methodology.

14.3 *Bias*—This test method has no bias because jet fuel thermal oxidative stability is defined only in terms of this test method.

15. Keywords

15.1 differential pressure; fuel decomposition; oxidative deposits; test filter deposits; thermal stability; turbine fuel

ANNEXES

(Mandatory Information)

A1. TEST METHOD FOR VISUAL RATING OF JFTOT HEATER TUBES

A1.1 Scope

A1.1.1 This method covers a procedure for visually rating the heater tube produced by Test Method D 3241, JFTOT Procedure.

A1.1.2 The final result from this test method is a tube color rating based on an arbitrary scale established for this test method plus two additional yes/no criteria that indicate the presence of an apparent large excess of deposit or an unusual deposit, or both.

A1.2 Referenced Documents

A1.2.1 *Adjunct:*

Color Standard for Tube Deposit Rating⁵

A1.3. Terminology

A1.3.1 *abnormal*—a tube deposit color that is neither peacock nor like those of the Color Standard.

A1.3.1.1 *Discussion*—This refers to deposit colors such as blues and grays that do not match the Color Standard.

A1.3.2 *peacock*—A multicolor, rainbow-like tube deposit.

A1.3.2.1 *Discussion*—This type of deposit is caused by interference phenomena where deposit thickness exceeds the quarter wave length of visible light.

A1.3.3 *Tube Rating*—A ten step discrete scale from 0 to >4 with intermediate levels for each number starting with 1 described as less than the subsequent number.

A1.3.3.1 *Discussion*—The scale is taken from the five colors—0, 1, 2, 3, 4—on the ASTM Color Standard. The complete scale is: 0, <1, 1, <2, 2, <3, 3, <4, 4, >4. Each step is not necessarily of the same absolute magnitude. The higher the number, the darker the deposit rating.

A1.4 Summary of Test Method

A1.4.1 This test method uses a specially constructed light box to view the heater tube. The tube is positioned in the box using a special tube holder. Uniformity of the new tube surface is judged under the optimum light conditions of the box. Color of the tube is judged under light and magnification by comparing to the Color Standard plate slid into optimum position immediately behind the tube.

A1.5 Significance and Use

A1.5.1 The final tube rating is assumed to be an estimate of condition of the degraded fuel deposit on the tube. This rating is one basis for judging the thermal oxidative stability of the fuel sample.

A1.6 Apparatus

A1.6.1 *Heater Tube Deposit Rating Apparatus*—The colors of deposits on the heater tube are rated by using a tuberator and the ASTM Color Standard.

A1.7 Test Samples (Coupons)

A1.7.1 Handle the heater tube coupon carefully so as not to touch the center portion at any time.

NOTE A1.1—Touching the center of the coupon will likely contaminate or disturb the surface of the tube, deposit, or both, which must be evaluated in pristine condition.

A1.8 Standard Operating Conditions

A1.8.1 *Inside of Light Box*, opaque black.

A1.8.2 *Light Source*, three 30 W incandescent bulbs, reflective type; all must be working for optimum viewing.

A1.8.3 *Bulb Positions*, one above, two below, each directed toward tube holder and color standard.

A1.8.4 *Magnification*, 2×, covering viewing window.

A1.8.5 *Evaluators*—Use persons who can judge colors, that is, they should not be color blind.

A1.9 Calibration and Standardization

A1.9.1 No standardization is required for this test apparatus, but since the Color Standard is known to fade, store it in a dark place.

NOTE A1.2—The lifetime of the Color Standard is not established when continuously or intermittently exposed to light. It is good practice to keep a separate Standard in dark (no light) storage for periodic comparison with the Standard in regular use. When comparing, the optimum under the light conditions are those of the tube rating box.

A1.9.2 Standardization of Rating Technique:

A1.9.2.1 In rating a tube, the darkest deposits are most important. Estimate grades for the darkest uniform deposit, not for the overall average color of the deposit area.

A1.9.2.2 When grading, consider only the darkest continuous color that covers an area equal or larger than a circle of size one-half the diameter of the tube.

A1.9.2.3 Ignore a deposit streak that is less in width than one-quarter the diameter of the tube regardless of the length of the streak.

A1.9.2.4 Ignore spots, streaks, or scratches on a tube that are considered tube defects. These will normally not be present since the tube is examined before use to eliminate defective tubes.

A1.10 Pretest Rating of Tubes

A1.10.1 Examine the tube without magnification in laboratory light. If a defect is visible, discard the tube. Then examine the center (thinner area) of the tube between 5 and 55 mm above the bottom shoulder using the Tuberator. If a defect is seen, establish its size. If it is larger than 2.5 mm², discard the tube. Fig. A1.1 provides an illustration of defect areas equivalent to 2.5 mm².

A1.10.2 Examine the tube for straightness by rolling the tube on a flat surface and noting the gap between the flat surface and the center section. Reject any bent tube.

A1.11 Procedure

A1.11.1 Set Up:

A1.11.1.1 Snap the upper end of the heater tube into the clamp of the holder for the heater tube.

A1.11.1.2 Push the heater tube against the stop of the holder for the heater tube.

A1.11.1.3 Slide the holder with the heater tube over the guide rod into the tuberator.

A1.11.1.4 Rotate the holder and position the heater tube such that the side with the darkest deposit is visible.

A1.11.1.5 Insert the ASTM Color Standard into the tuberator.

A1.11.2 Evaluation:

A1.11.2.1 On completion of the test, compare the darkest heater tube deposit color, between 5 and 55 mm above the bottom shoulder, with the ASTM Color Standard. Only rate a deposit if the area is greater than 2.5 mm² and the width of any

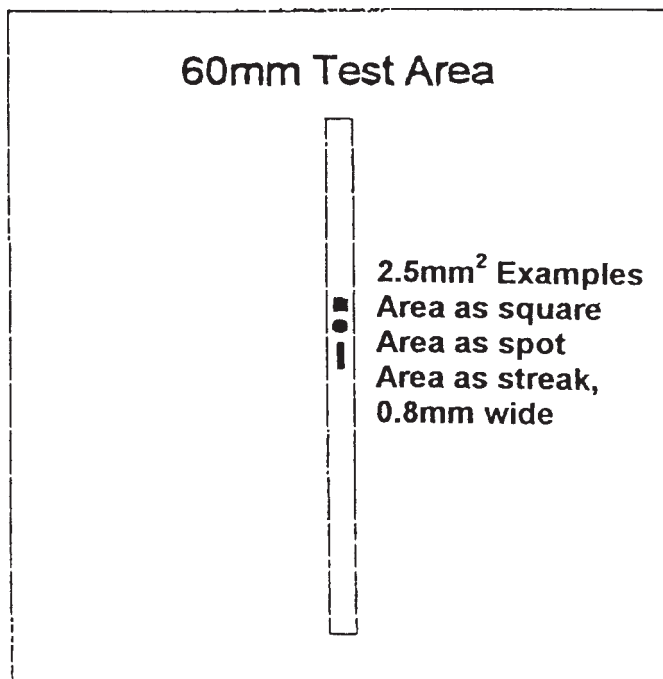

FIG. A1.1 Defect Areas

streak or spot is greater than 0.8 mm. Fig. A1.1 provides an illustration of spots or streaks with an area equivalent to 2.5 mm².

A1.11.2.2 When the darkest deposit color corresponds to a color standard, that number should be recorded.

A1.11.2.3 If the darkest heater tube deposit color being rated is in the obvious transition state between any two adjacent color standards, the rating should be recorded as less than the darker (that is, higher number) standard.

A1.11.2.4 In the event the heater tube has deposits which do not match the normal Color Standard colors, use the following rules for rating. With reference to standard terms:

(1) If the deposit is peacock color, rate this as Code P, but also rate any deposit that shows normal deposit color; or

(2) If the deposit contains an abnormal color, rate this as Code A, but also rate any deposit that shows normal deposit color.

A1.11.3 Remove the rated heater tube and return to its original container.

A1.12 Report

A1.12.1 Report the numerical rating for the heater tube plus A or P, or both, with additional description, if applicable.

A1.12.1.1 When reporting the overall rating, report the maximum rating, and, if there are colors present which do not match the Color Standard, report these also.

A1.12.1.2 If there are only P or A, or both, deposits, report only these and do not attempt to estimate a numerical grade.

A1.12.2 Examples:

A1.12.2.1 *Example 1*—A heater tube has a maximum deposit falling between Color Standard Codes 2 and 3 with no other colors present. The overall tube rating would be less than 3.

A1.12.2.2 *Example 2*—The darkest deposit on a tube matches a Code 3, but there is also a peacock deposit present. The overall rating of the tube would be reported as 3P.

A1.12.2.3 *Example 3*—A heater tube has a deposit that matches Color Standard Code 1 and also has an abnormal deposit. The overall tube rating would be reported as 1A.

A1.13 Precision and Bias

A1.13.1 *Precision*—The precision of the procedure in Test Method D 3241 for measuring tube deposit rating is being determined.

A1.13.2 *Bias*—The procedure in Test Method D 3241 for determining tube deposit rating has no bias because the value of tube deposit rating is defined only in terms of the test method.

A2. EQUIPMENT

A2.1 Test Instrument

A2.1.1 The instrument described in this annex is the Jet Fuel Thermal Oxidation Tester, or JFTOT, that is used to test the thermal oxidation stability of turbine fuel. There are five models of JFTOT which will be described. All provide a means to pump the sample once through the test system across the metal test coupon and through a test filter. There are means to control and measure coupon temperature, system pressure, and pressure drop across the filter, and methods of control and measurement vary with each model of JFTOT. Mechanism for pumping is positive displacement using a gear pump or piston pump.

A2.2 Test Details

A2.2.1 *General Description*—This instrument uses a fixed volume of jet fuel that has been filtered, then aerated to provide a sample saturated with air. During the test, fuel is pumped at a steady rate across a heated aluminum tube which is maintained at a relatively high temperature, typically 260°C, but higher under some specifications. The fuel, saturated with oxygen from the aeration, may degrade on the hot aluminum heater tube to form deposits as a visible film. Also, the degraded materials of the fuel may flow downstream and be caught by the test filter. Both the increase in differential pressure across the test filter and the final heater tube rating are used to determine the oxidative stability of the fuel.

A2.2.2 *Fuel System*—Freshly filtered and aerated fuel is initially placed in a reservoir, then circulated once through the apparatus to a spent sample receptacle. Motive force for the sample is a positive displacement pump that will maintain flow at 3.0 mL/min and overcome any tendency of initial filter blockage from affecting the flow rate. Deviation of 10 % in flow rate is permitted. If filter blockage becomes severe, the bypass valve located before the test filter can be opened in order to finish the test. Then, any deposit on the heater tube can be evaluated based on a complete test.

A2.2.2.1 The heart of the test system is the tube-in-shell heat exchanger, or test section, which holds the test coupon and directs flow of fuel over it. It is important for the heater tube to be aligned correctly in the heater test section as shown in Fig. A2.1. This component is critical to consistent results and is a common component in all JFTOT models.

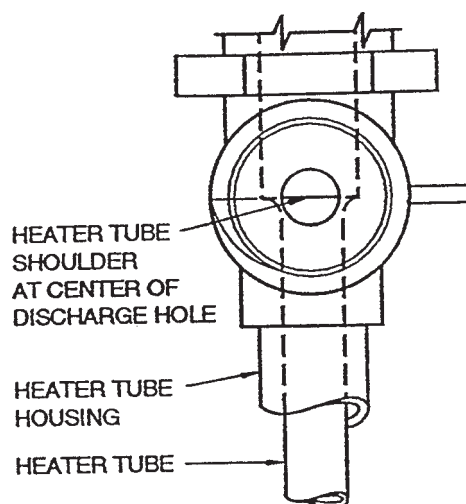

FIG. A2.1 Alignment of Heater Tube

A2.2.2.2 There are some other points regarding the fuel system that deserve mention:

(1) Fresh fuel is filtered immediately out of the reservoir through 0.45 μm membrane filter paper before entering the heater test section;

(2) The heater tube is sealed in the heater test section by elastomer O-rings (Fig. A2.2);

(3) The test filter is of stainless steel of 17μm rated porosity. If this filter causes an increase in differential pressure, an alarm will sound (normally at 125 mm Hg) alerting the operator. Bypass of the filter can then be accomplished if desired;

(4) Models 202, 203, and 215 JFTOT's use a single fuel reservoir with a floating piston to separate the fresh fuel (in bottom) and spent fuel (on top). Models 230 and 240 use two reservoirs, one for fresh fuel and one for spent;

(5) Flow of fuel in all models can be monitored by visually counting drops of flow. Model 230 and 240 JFTOT's also allow volumetric measure of flow with time which is considered the most accurate flow measure.

A2.2.2.3 Diagrams of fuel flow through the three main configurations of JFTOT are shown in Fig. A2.3.

A2.2.3 *Heating/Temperature Control System*—The heater tube is resistively heated by the conductance of high amperage, low voltage current from a transformer through the aluminum

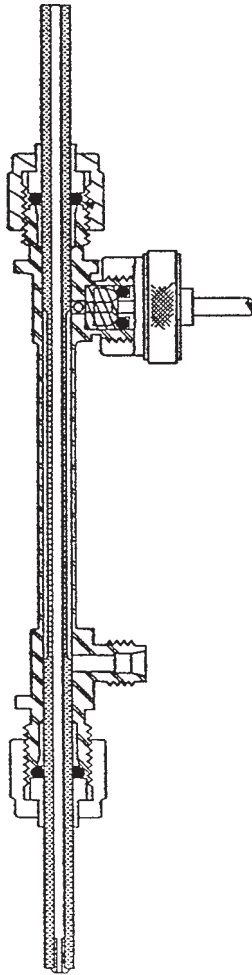

FIG. A2.2 Assembly Drawing of Heater Tube Test Section

tube. The heater tube is clamped to relatively heavy, water cooled current conducting bus bars which increase in temperature relatively little.

A2.2.3.1 The temperature controller in all models of JFTOT serves as indicator and controller. In automatic mode, the controller provides a source of steady heat during the test varying the power as necessary to maintain the target (setpoint) temperature. In manual mode, the controller provides temperature indication only. Temperature range of operation is from ambient to a maximum of about 350°C.

A2.2.3.2 Critical to temperature control is the thermocouple and its position. The thermocouple itself must be calibrated to ensure acceptable accuracy. The position of the tip must be carefully placed so the temperature reading during automatic control is the maximum (the hottest spot) for the heater tube. A simple mechanical positioning system allows easy and accurate placement of the thermocouple.

A2.2.3.3 A diagram of the basic heating system is shown in Fig. A2.4.

A2.2.4 *Cooling System*—In the normal operation of the JFTOT, some cooling is necessary to remove heat going into the bus bars by conduction from the hot heater tube. Cooling water is circulated through each bus bar using either laboratory tap water (Models 202, 203, and 215 JFTOT) or an internally

circulated and radiator cooled liquid system (Models 230 and 240). The only precautions with these systems is to monitor them to be sure they are working and to avoid use of coolants that contain contaminants or salts that may eventually foul the system.

A2.2.5 *Pressurization*—At the temperature of a normal JFTOT test, jet fuel would typically boil at the temperature of the heater tube. This would prevent accurate temperature control and interfere with natural deposit formation. Therefore, the system must be operated under a total pressure of about 3.45 MPa (500 psi). This pressure level is accomplished in each model by either using nitrogen gas (Models 202, 203, and 215) or a hydraulic piston pump (Models 230 and 240) to produce the high pressure needed.

A2.2.5.1 A pressure gage or transducer is used to measure and allow monitoring of the total system pressure. Of particular note is that the gas pressurized systems are run closed after pressurization whereas the hydraulically pressurized systems have a relief valve through which the fluid passes in a constant leak throughout the test. For the relief valve control to operate uniformly for any fuel, a displacement cell is used where the spent fuel enters the top displacing water out the bottom and through the relief valve. Since the valve sees only water, the valve works consistently.

A2.2.6 *Differential Pressure Measure*—There are two instrument configurations used in JFTOT models to measure differential pressure (ΔP) across the test filter as products of fuel degradation are caught by the filter during the test. Models 202 and 203 (before 1984) use a mercury manometer with a possible strip chart ΔP recording option. Models 215, 230, and 240 use an electronic ΔP transducer. Details of how these two methods are included in the fuel schematic can be seen in the diagrams under Fuel System (see Fig. A2.3).

A2.2.6.1 Proper use of these differential measuring devices requires two special actions: bypass and air bleeding. The first allows the fuel flow to bypass the filter whenever that action becomes necessary. The second is used to remove air or nitrogen that at times may become trapped in the cell chambers. The manometer output is read as the height of the column of mercury; the transducer output must be displayed digitally.

A2.2.6.2 The manometer system, by nature, includes a bias due to the presence of fuel instead of the usual air over the mercury. This changes the value of pressure expressed in terms of column height of mercury such that a result about 6 % higher than true occurs. The transducer is not subject to this error, so in order to have manometer and transducer models read the same, a 6 % bias is added to the transducer so it gives the same value as a manometer.

A2.2.6.3 When operated, the ΔP measuring device employed must be zeroed under actual flow conditions at the start of the test. This is because a small pressure drop is created across the system when fuel is flowing. Zeroing the transducer or manometer at the beginning of the test compensates for the flow.

A2.2.7 *Differential Pressure Measurement Standardization*—The ΔP measurement accuracy can be checked by a technique of reading the pressure created by a column of known density fluid on each side of the ΔP cell. The

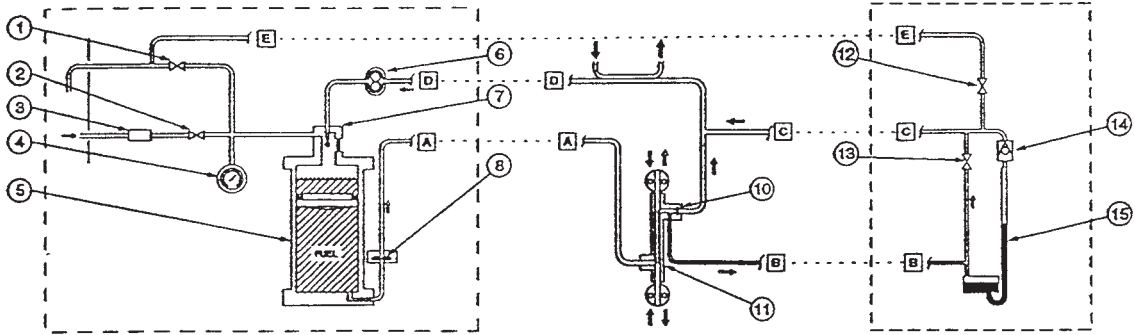

JFTOT - pneumatically pressurized / gear pump / mercury manometer / standard test section

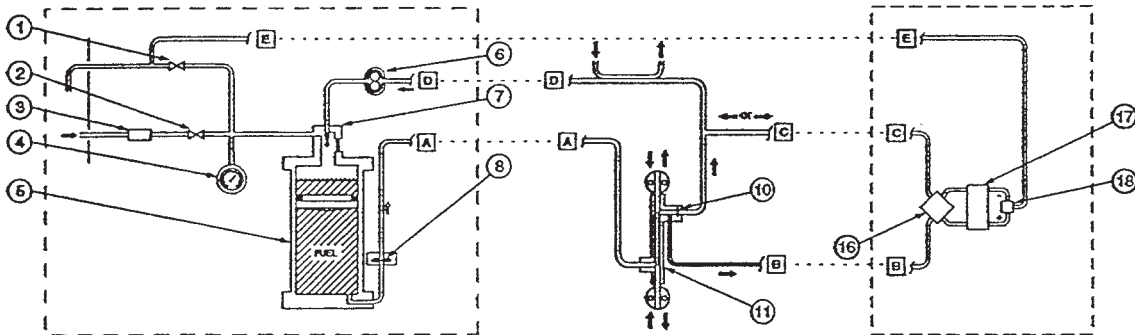

JFTOT - pneumatically pressurized / gear pump / differential transducer / standard test section

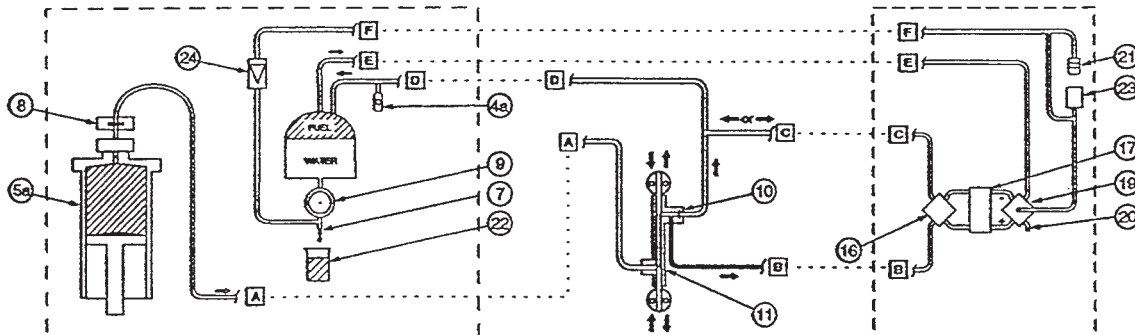

JFTOT - hydraulically pressurized / syringe pump / differential transducer / standard test section

- | | | |
|---|---------------------------------------|---|
| 1. Nitrogen Bleed Valve | 8. Membrane Prefilter | 17. Liquid Full Differential Transducer |
| 2. Nitrogen Pressurize Valve | 9. Pressure Regulator | 18. 3 Way Vent (Bleed) Valve |
| 3. Pressure Limiter | 10. Test Filter | 19. 5 Way Vent (Bleed) Valve |
| 4. Pressure Gage | 11. Standard Heater Tube Test Section | 20. Plugged Outlet |
| 4a. Absolute Pressure Gage (Transducer) | 12. Manual Bleed Valve | 21. Air Trap Jar |
| 5. Fuel Reservoir w/ Piston and Seal | 13. Filter Bypass Valve | 22. Spent Liquid |
| 5a. Hydraulic Fuel Reservoir | 14. Float Check Valve | 23. Accumulator |
| 6. Const. Speed Metering Pump | 15. Manometer | 24. Check Valve |
| 7. Drip Flow Indicator | 16. 4 Way Transducer Bypass Valve | |

FIG. A2.3 Fuel System Schematics

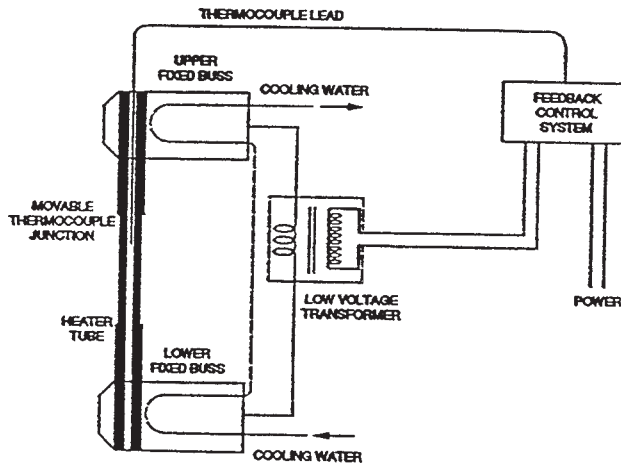

FIG. A2.4 Heater Tube and Temperature Control Schematic

details for doing this are included as part of each operating manual for the particular model JFTOT. This standardization is really a verification that the ΔP cell is operating correctly and is not meant to be a true calibration of the cell. Calibration must be done by the manufacturers of the cell if such action is suggested based on the results of the standardization.

A2.2.8 Thermocouple Calibration—It is important for the thermocouple to be accurate. To ensure this value, a method of calibration against known melting points is used and is described in detail in the appropriate User Manual for each JFTOT. With the first JFTOT models, only pure tin was used as the indicator metal. Starting with JFTOT Models 230 and 240 the use of two metals, pure tin at 232°C and pure lead at 327°C, was initiated to define two points surrounding the normal range used with the instrument. Also, an ice-water mixture is used to establish a 0°C low reference point.

A2.2.8.1 The principle used with melting point of metals is to immerse the thermocouple tip in the melted metal, then allow the metal to cool. As the metal goes through its freeze point, the temperature reading will hesitate momentarily indicating the known point for the metal.

A2.2.8.2 The difference between the known metal freezing value and the displayed temperature becomes a correction for setting test temperatures. For example, using tin with a known freeze temperature of 232°C (see Fig. A2.5), if the temperature noted at the time the metal froze was higher than 232°, then this would indicate the thermocouple was reading high by the difference indicated and the applied correction would be to lower any test temperature by this same amount. Where two metals and ice water (low point) are used the principle is the

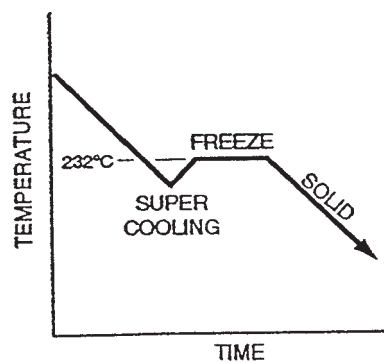

FIG. A2.5 Freezing Characteristics of Tin

same but the correction is calculated and applied automatically by the internal computer.

A2.2.9 Fuel Aeration System—All JFTOT models have means to aerate the sample prior to testing. Without the presence of oxygen in the sample, a proper test is not achieved. Filtered, dry air is metered through the sample at about 1.5 L/min rate for 6 min. This 9 L of air ensures 97 % saturation of the sample.

A2.2.10 Elapsed Time Measurement—There are various methods of timing the test depending on the model of JFTOT. The elapsed time indicator is normally the basis used, but in some models the timing of the ΔP data collection is done with a different timer. Since these two timers may not be exactly the same, the last data point may be lost if the test stops before the last timed data point. The user manuals for the various instrument models cover techniques for avoiding loss of data points.

A3. PRECAUTIONARY STATEMENTS

A3.1 Acetone

- A3.1.1 Keep away from heat, sparks, and open flame.
- A3.1.2 Keep container closed. Use with adequate ventilation.
- A3.1.3 Avoid buildup of vapors and eliminate all sources of ignition, especially nonexplosion-proof electrical apparatus and heaters.

A3.2 Toluene

- A3.2.1 Avoid prolonged or repeated breathing of vapor or spray mist.
- A3.2.2 Use only with adequate ventilation.
- A3.2.3 Eye irritation and dizziness are indications of over-exposure.
- A3.2.4 Do not take internally.
- A3.2.5 Swallowing may cause injury, illness, or death.
- A3.2.6 Avoid prolonged or repeated contact with skin.
- A3.2.7 Do not get in eyes.
- A3.2.8 Can produce toxic vapors on contact with flames, hot glowing surfaces, or electric arcs.

A3.3 Iso-propanol (2-propanol)

- A3.3.1 Keep away from heat, sparks, and open flame.
- A3.3.2 Keep container away from heat, sparks, and open flame.
- A3.3.3 Keep container closed.
- A3.3.4 Use with adequate ventilation.
- A3.3.5 Avoid buildup of vapors and eliminate all sources of ignition, especially nonexplosion-proof electrical apparatus and heaters.
- A3.3.6 Avoid prolonged breathing of vapor or spray mist.
- A3.3.7 Avoid prolonged or repeated skin contact.

A3.4 n-heptane

- A3.4.1 Keep away from heat, sparks, and open flame.
- A3.4.2 Keep container closed.
- A3.4.3 Use with adequate ventilation.
- A3.4.4 Avoid prolonged breathing of vapor or spray mist.
- A3.4.5 Avoid prolonged or repeated skin contact.

A3.5 Compressed Gases (Nitrogen)

- A3.5.1 Keep cylinder valve closed when not in use.
- A3.5.2 Do not enter storage areas unless adequately ventilated.
- A3.5.3 Always use a pressure regulator.

- A3.5.4 Release regulator tension before opening cylinder.
- A3.5.5 Do not transfer to cylinder other than one in which gas is received.
- A3.5.6 Do not mix gases in cylinders.
- A3.5.7 Never drop cylinder.
- A3.5.8 Make sure cylinder is supported at all times.
- A3.5.9 Stand away from cylinder outlet when opening cylinder valve.
- A3.5.10 Keep cylinder out of sun and away from heat.
- A3.5.11 Keep cylinder from corrosive environment.
- A3.5.12 Do not use cylinder without label.
- A3.5.13 Do not use dented or damaged cylinders.
- A3.5.14 For technical use only.
- A3.5.15 Do not use for inhalation purposes.

A3.6 Aviation Turbine Fuel (Jet B, See Specification D 1655)

- A3.6.1 Keep away from heat, sparks, and open flames.
- A3.6.2 Keep container closed.
- A3.6.3 Use with adequate ventilation.
- A3.6.4 Avoid breathing vapor or spray mist.
- A3.6.5 Avoid prolonged or repeated contact with skin.

A3.7 Aviation Turbine Fuel (Jet A or A-1, See Specification D 1655)

- A3.7.1 Keep away from heat, sparks, and open flame.
- A3.7.2 Keep container closed.
- A3.7.3 Use with adequate ventilation.
- A3.7.4 Avoid buildup of vapors and eliminate all sources of ignition, especially nonexplosion-proof electrical apparatus and heaters.
- A3.7.5 Avoid breathing vapor or spray mist.
- A3.7.6 Avoid prolonged or repeated contact with skin.

A3.8 Mercury

- A3.8.1 Do not breathe vapor.
- A3.8.2 Keep container closed.
- A3.8.3 Use with adequate ventilation.
- A3.8.4 Do not take internally.
- A3.8.5 Cover exposed surfaces with water if possible, to minimize evaporation.
- A3.8.6 Do not heat.
- A3.8.7 Keep recovered mercury in tightly sealed container prior to sale or purification.
- A3.8.8 Do not discard in sink or in rubbish.

APPENDIXES

X1. INSTALLATION, MAINTENANCE, SPECIAL CHECKS

X1.1 Laboratory Installation Requirements

X1.1.1 The tester should be placed on a level laboratory bench, allowing a 200 to 300 mm wide bench area in front of the tester. Ready access to the rear of the tester should be provided for routine maintenance and service requirements. Ensure that the vent on top or side of the JFTOT cabinet is not obstructed during installation or use. Adequate ventilation should be provided, and proper procedures for handling solvents and hydrocarbons should be used. A constant voltage transformer may be required by early versions of the instrument. Single-phase electrical power, 115 V-60 Hz-15 Amp or optional 220V-50 Hz-8 Amp with a ground outlet is required.

X1.1.2 For pneumatic model JFTOT's, a nitrogen supply bottle with a suitable regulator capable of supplying 3.45 MPa should be placed conveniently and connected with 3.2-mm diameter tubing to the tester. A suitable 6.4-mm diameter line needs to be connected from the WATER INLET connection to a 200 to 700 kPa water supply and a 6.4-mm diameter line needs to be connected from WATER DRAIN to a drain having a minimum capacity to receive 80 L/h.

X1.2 AutoCal Calibrator Metal Replacement

X1.2.1 The tin (and lead, if used) in the well of the AutoCal Calibrator must be replaced whenever the quantity is below minimum or when contaminated.

X1.2.2 To remove the metal, install the AutoCal Calibrator inverted between the upper fixed bus and the lower floating bus.

X1.2.3 Place a paper tissue or rag under the well to catch the molten metal.

X1.2.4 Apply power to the AutoCal Calibrator as during normal calibration, and at same time gently tap the well until all molten metal has dropped out.

X1.2.5 Remove and install the AutoCal Calibrator in upright position and refill with new metal. The proper amount of tin for one filling is about 1.5 to 1.9 g, and for lead about 3.3 to 4.7 g.

X1.3 Thermocouple Replacement and Position Adjustment

X1.3.1 The thermocouple used for measuring and controlling the temperature of the JFTOT heater tube may have to be replaced at intervals due to damage or failure. If not of the simple plug in type, remove the thermocouple, loosen the thermocouple clamp, support clamp, and thermocouple connections on back of the temperature controller.

X1.3.2 Install a new thermocouple reversing the steps used to remove old thermocouple. Replace and tighten screws as required. If applicable, when tightening the Allen screw of thermocouple clamp, the tip of the thermocouple must be flush with top of upper fixed bus when position indicator is set at the reference mark.

X1.3.3 Check for proper thermocouple indexing under actual test operating conditions.

X1.4 Heater Tube Temperature Profile

X1.4.1 If it is desired to measure the heater tube temperature profile, do so after the first hour of the test or before significant ΔP occurs. Follow the procedure in the user manual for the particular model JFTOT.

X1.5 Filter Bypass Valve Leakage Check (Models 202, 203, and 215 only)

X1.5.1 Obtain a used filter and plug the upstream side with any fast-drying glue such as industrial adhesive. Install this filter together with any heater tube in the test section.

X1.5.2 Circulate clean filtered fuel at 3.45 MPa with MAN BYPASS valve in the open position (no heat applied).

X1.5.3 After steady flow is observed in the sight glass (20 drops in 9.0 ± 1.0 s), close the MAN BYPASS valve and simultaneously start a stopwatch. Observe the time required for the ΔP to reach 100 mm. Immediately open the MAN BYPASS valve to resume normal fuel flow.

X1.5.4 If the time measured to reach 100 mm ΔP is equal to or less than 60 s, the MAN BYPASS valve and the fuel pump meet normal performance requirements.

X1.5.5 The time required for the ΔP to exceed 100 mm can be quite short; in some equipment the increase may occur almost instantly depending on pump condition and system details. Such a rapid rise in ΔP is acceptable and considered to be within the range of expected and normal operation.

X1.5.6 If the time measured to reach 100 mm ΔP exceeds 60 s, either the filter bypass valve is leaking or the fuel metering pump performance is unsatisfactory. In this case, the fuel metering pump performance should be checked to determine if the pump or filter bypass valve needs to be replaced.

X1.6 Fuel Metering Pump Check (Gear Pumps Only)

X1.6.1 Install a plugged filter, used heater tube, and establish normal fuel flow.

X1.6.2 After steady flow is established, adjust the MAN BYPASS valve to maintain a steady ΔP of 50 mm.

X1.6.3 Measure the time with a stopwatch for 20 drops flow rate as observed in the sight glass.

X1.6.4 The time for a properly performing fuel pump is 9.0 ± 1.0 s for 20 drops fuel flow rate. Pumps that measure above 10 s should be replaced.

X1.6.5 After installing a new pump, repeat the pump check.

X1.6.6 If low flow persists, clean all lines and fittings from the test filter through the metering pump to the fuel reservoir with tri-solv. Replace lines as necessary. Repeat pump check.

X1.7 Maintenance Manual

X1.7.1 A maintenance manual is available⁶ that provides additional maintenance information, such as the electrical schematic (also available on inside of back door of JFTOT cabinet). Complete details for operating the JFTOT models are contained in the user manuals for each instrument.

X2. DETERMINATION OF BREAKPOINT

X2.1 Definition

X2.1.1 *Breakpoint*—In Test Method D 3241 (JFTOT), *breakpoint* is the highest control temperature at which the fuel meets tube rating and ΔP specification requirements.

X2.1.1.1 *Discussion*—This definition of breakpoint describes the highest pass temperature for a fuel. Note that some published papers have used the term breakpoint to describe the lowest fail temperature, which is the $(x + 5)^{\circ}\text{C}$ temperature referred to below.

X2.2 Determination of Breakpoint

X2.2.1 The breakpoint can be derived by conducting a series of tests of different control temperatures to arrive at the temperature, $x^{\circ}\text{C}$, at which the fuel meets both tube rating and ΔP specification requirements, and where a test at a control temperature of $(x + 5)^{\circ}\text{C}$ would result in a fail (that is, failure to meet tube rating or ΔP requirements). The temperature $x^{\circ}\text{C}$ would then be reported as the Test Method D 3241 breakpoint.

ASTM International takes no position respecting the validity of any patent rights asserted in connection with any item mentioned in this standard. Users of this standard are expressly advised that determination of the validity of any such patent rights, and the risk of infringement of such rights, are entirely their own responsibility.

This standard is subject to revision at any time by the responsible technical committee and must be reviewed every five years and if not revised, either reapproved or withdrawn. Your comments are invited either for revision of this standard or for additional standards and should be addressed to ASTM International Headquarters. Your comments will receive careful consideration at a meeting of the responsible technical committee, which you may attend. If you feel that your comments have not received a fair hearing you should make your views known to the ASTM Committee on Standards, at the address shown below.

This standard is copyrighted by ASTM International, 100 Barr Harbor Drive, PO Box C700, West Conshohocken, PA 19428-2959, United States. Individual reprints (single or multiple copies) of this standard may be obtained by contacting ASTM at the above address or at 610-832-9585 (phone), 610-832-9555 (fax), or service@astm.org (e-mail); or through the ASTM website (www.astm.org).